

Features

- Easy parallel switching capability due to positive temperature coefficient in V_{CEsat}
- Low V_{CEsat} , fast switching
- High ruggedness, good thermal stability
- Very tight parameter distribution

Type	Marking	Package
MPBQ50N120B	MP50N120B	TO-247-3L Plus

Applications

- Solar Inverter
- UPS
- Welding

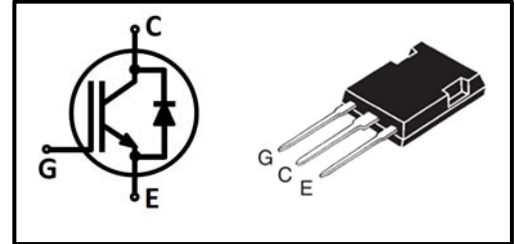

Maximum Rated Values

Parameter	Symbol	Value	Unit
Collector-emitter voltage	V_{CE}	1200	V
DC collector current, limited by T_{vjmax} $T_C=25^\circ\text{C}$ $T_C=135^\circ\text{C}$	I_C	100 50	A
Pulsed collector current, t_p limited by T_{vjmax} ¹⁾	I_{Cpuls}	200	
Turn off safe operating area $V_{CE} \leq 1200\text{V}$, $T_{vj} \leq 175^\circ\text{C}$, $t_p = 1\mu\text{s}$	-	200	
Diode forward current, limited by T_{vjmax} $T_C=25^\circ\text{C}$ $T_C=100^\circ\text{C}$	I_F	100 50	
Diode pulsed current, t_p limited by T_{vjmax} ¹⁾	I_{Fpuls}	200	V
Gate-emitter voltage	V_{GE}	± 20	
Transient gate-emitter voltage ($t_p \leq 10\mu\text{s}$, $D < 0.01$)		± 30	
Power dissipation $T_C=25^\circ\text{C}$	P_{tot}	600	W
Power dissipation $T_C=135^\circ\text{C}$		160	
Operating junction temperature	T_{vj}	-40~175	°C
Storage temperature	T_{stg}	-55~150	
Soldering temperature, wave soldering 1.6mm (0.063in.) from case for 10s		260	

¹⁾ Defined by design. Not subject to production test.



Thermal Characteristics

Parameter	Symbol	Min	Typ	Max	Unit
IGBT thermal resistance, junction-case	R_{thJC}	-	-	0.25	K/W
Diode thermal resistance, junction-case	R_{thJCD}	-	-	0.48	
Thermal Resistance, junction-ambient	R_{thJA}	-	-	40	

Electrical Characteristics (at $T_{vj}=25^{\circ}C$, unless otherwise specified) Static Characteristics

Parameter	Symbol	Conditions	Min	Typ	Max	Unit
Collector-emitter breakdown voltage	$V_{(BR)CES}$	$V_{GE}=0V, I_C=0.25mA$	1200	-	-	V
Collector-emitter saturation voltage	$V_{CE(sat)}$	$V_{GE}=15V, I_C=50A$ $T_{vj}=25^{\circ}C$	-	1.80	2.30	
		$T_{vj}=150^{\circ}C$	-	2.35	-	
		$T_{vj}=175^{\circ}C$	-	2.50	-	
Diode forward voltage	V_F	$V_{GE}=0V, I_F=50A$ $T_{vj}=25^{\circ}C$	-	2.0	-	
		$T_{vj}=150^{\circ}C$	-	1.8	-	
		$T_{vj}=175^{\circ}C$	-	1.7	-	
G-E threshold voltage	$V_{GE(th)}$	$I_C=1.7mA, V_{CE}=V_{GE}$	5.2	5.8	6.4	
C-E leakage current	I_{CES}	$V_{CE}=1200V,$ $V_{GE}=0V$ $T_{vj}=25^{\circ}C$	-	-	0.1	mA
		$T_{vj}=175^{\circ}C$	-	-	4.0	
G-E leakage current	I_{GES}	$V_{CE}=0V, V_{GE}=20V$	-	-	100	nA

Dynamic Characteristics

Parameter	Symbol	Conditions	Min	Typ	Max	Unit
Input capacitance	C_{ies}	$V_{CE}=25V,$ $V_{GE}=0V,$ $f=1MHz$	-	6050	-	pF
Output capacitance	C_{oes}		-	145	-	
Reverse transfer capacitance	C_{res}		-	135	-	
Gate charge	Q_G	$V_{CC}=960V, I_C=50A,$ $V_{GE}=15V$	-	516	-	nC



IGBT Switching Characteristics

Parameter	Symbol	Conditions	Min	Typ	Max	Unit	
Turn-on delay time	$t_{d(on)}$	$T_{vj}=25^{\circ}C,$ $V_{CC}=600V,$ $I_C=50A,$ $V_{GE}=0/15V,$ $R_G=10\Omega,$ Inductive load	-	96	-	ns	
Rise time	t_r		-	121	-		
Turn-off delay time	$t_{d(off)}$		-	575	-		
Fall time	t_f		-	39	-		
Turn-on energy	E_{on}		$T_{vj}=175^{\circ}C,$ $V_{CC}=600V,$ $I_C=50A,$ $V_{GE}=0/15V,$ $R_G=10\Omega,$ Inductive load	-	5.50	-	mJ
Turn-off energy	E_{off}			-	3.21	-	
Total switching energy	E_{ts}			-	8.71	-	
Turn-on delay time	$t_{d(on)}$	$T_{vj}=175^{\circ}C,$ $V_{CC}=600V,$ $I_C=50A,$ $V_{GE}=0/15V,$ $R_G=10\Omega,$ Inductive load	-	90	-	ns	
Rise time	t_r		-	135	-		
Turn-off delay time	$t_{d(off)}$		-	655	-		
Fall time	t_f		-	82	-		
Turn-on energy	E_{on}		$T_{vj}=175^{\circ}C,$ $V_{CC}=600V,$ $I_C=50A,$ $V_{GE}=0/15V,$ $R_G=10\Omega,$ Inductive load	-	5.90	-	mJ
Turn-off energy	E_{off}			-	4.23	-	
Total switching energy	E_{ts}			-	10.13	-	

Diode Characteristics

Parameter	Symbol	Conditions	Min	Typ	Max	Unit
Diode reverse recovery time	t_{rr}	$T_{vj}=25^{\circ}C,$ $V_R=600V,$ $I_F=50A,$ $di_F/dt=400A/\mu s$	-	233	-	ns
Diode reverse recovery charge	Q_{rr}		-	2.76	-	μC
Diode peak reverse recovery current	I_{rrm}		-	18.8	-	A
Diode reverse recovery time	t_{rr}	$T_{vj}=175^{\circ}C,$ $V_R=600V,$ $I_F=50A,$ $di_F/dt=400A/\mu s$	-	465	-	ns
Diode reverse recovery charge	Q_{rr}		-	9.82	-	μC
Diode peak reverse recovery current	I_{rrm}		-	44.0	-	A

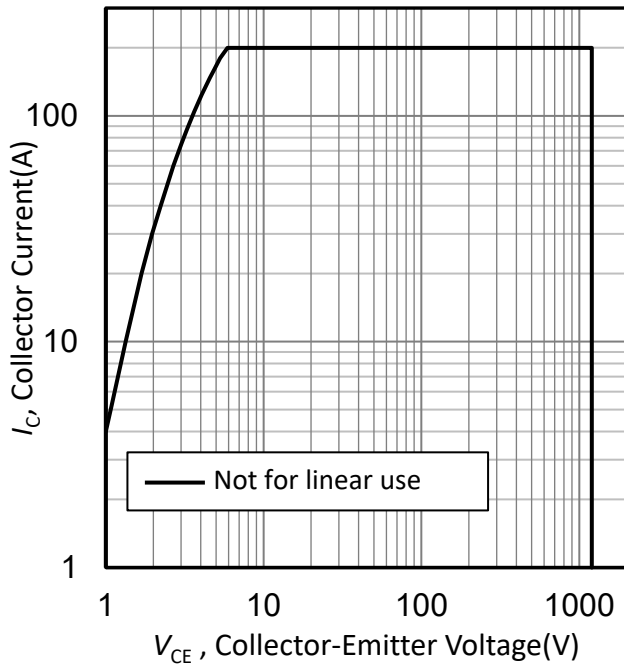

Figure 1. Forward bias safe operating area
($D=0, T_C=25\text{ }^\circ\text{C}, T_{vj}\leq 175\text{ }^\circ\text{C}, V_{GE}=15\text{V}$)

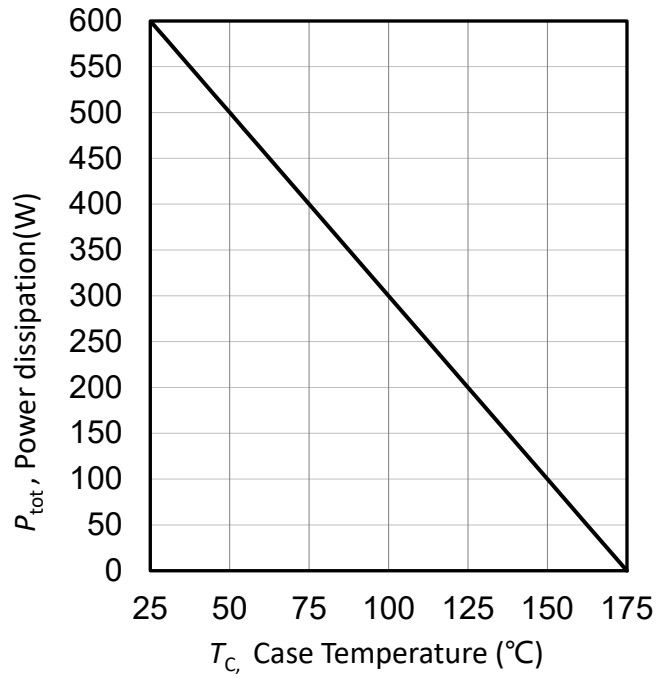

Figure 2. Power dissipation as a function of case temperature
($T_{vj}\leq 175\text{ }^\circ\text{C}$)

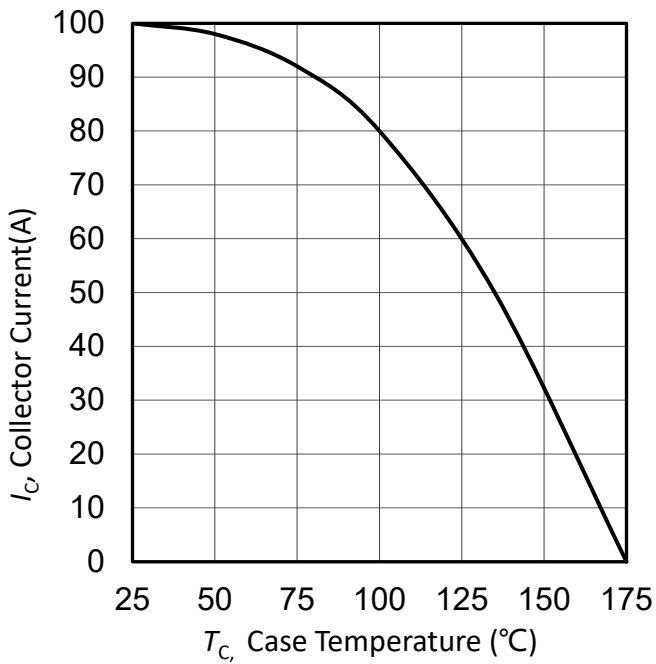

Figure 3. Collector current as a function of case temperature
($T_{vj}\leq 175\text{ }^\circ\text{C}, V_{GE}\geq 15\text{V}$)

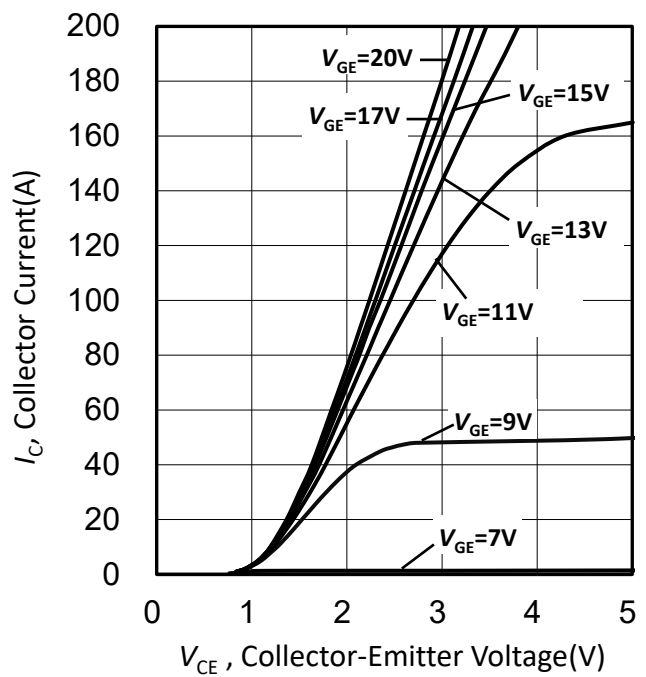

Figure 4. Typical output characteristic
($T_{vj}=25\text{ }^\circ\text{C}$)

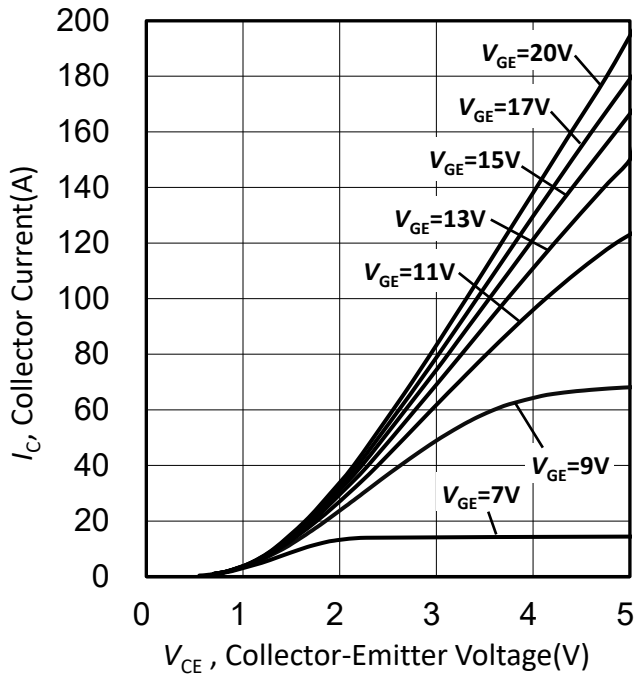

Figure 5. Typical output characteristic ($T_{vj}=175^{\circ}\text{C}$)

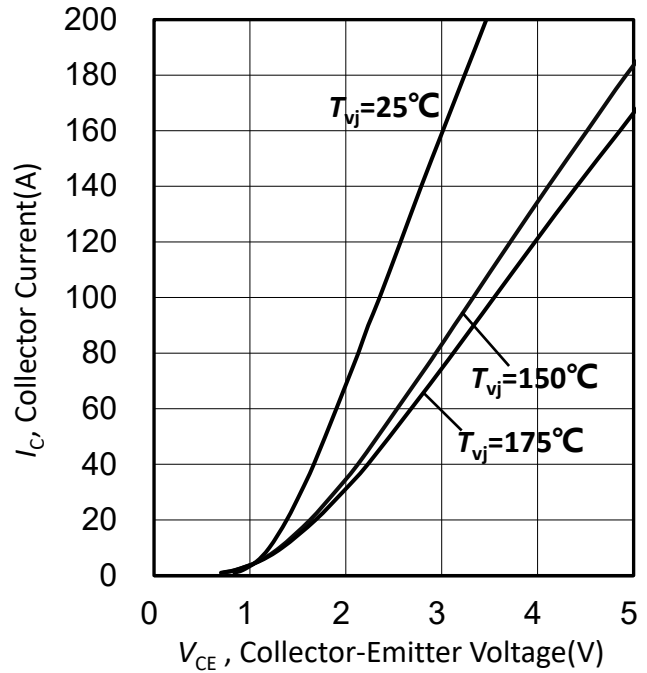

Figure 6. Collector-emitter saturation voltage characteristic ($V_{GE}=15\text{V}$)

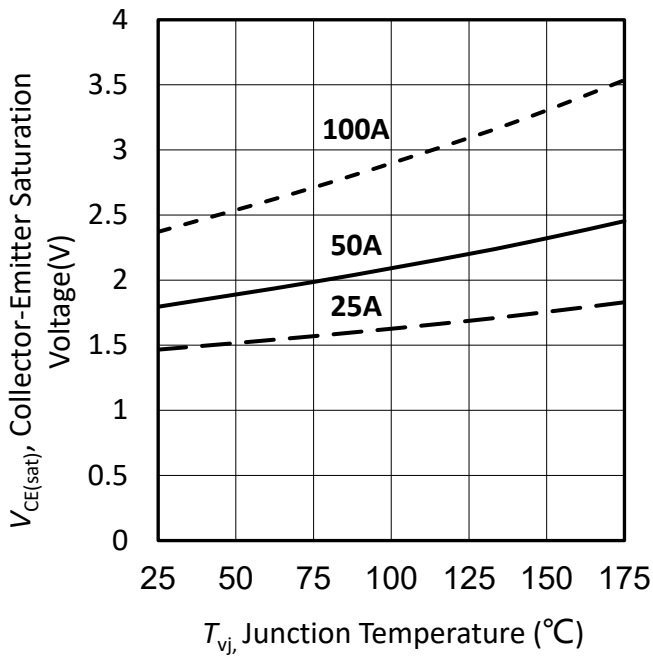

Figure 7. Typical collector-emitter saturation voltage as a function of junction temperature ($V_{GE}=15\text{V}$)

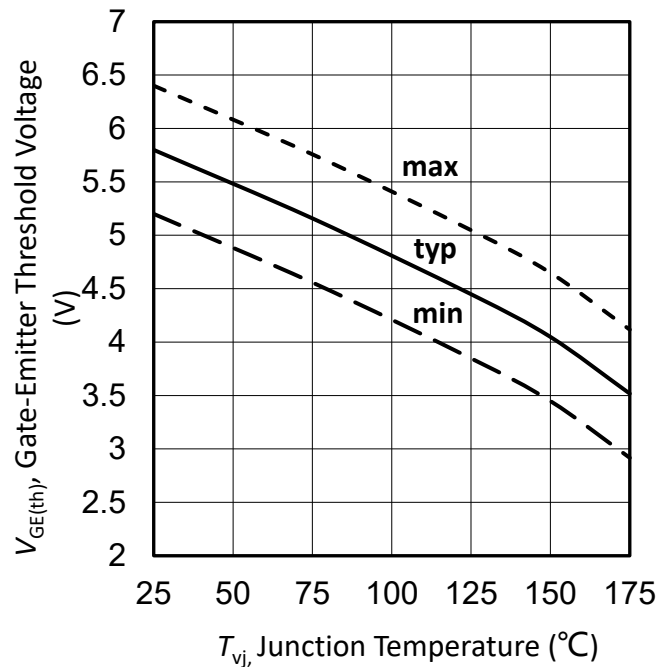

Figure 8. Gate-emitter threshold voltage as a function of junction temperature ($I_C=1.7\text{mA}$)

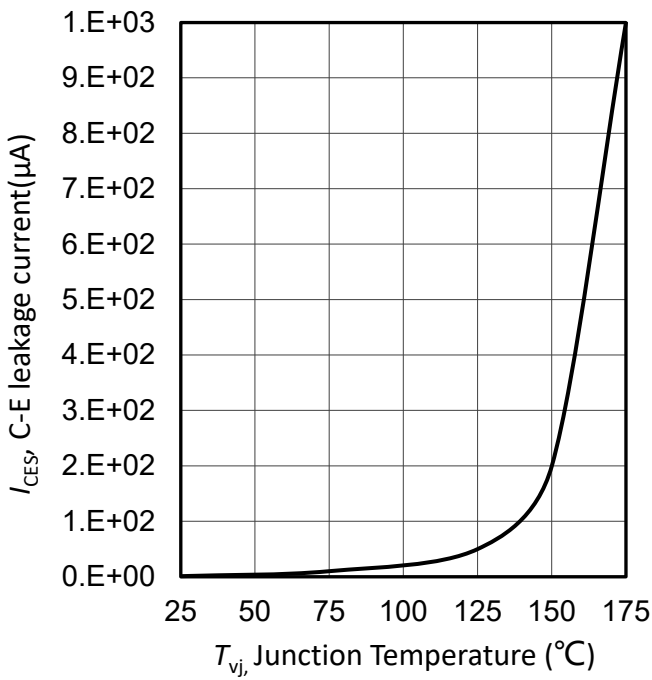

Figure 9. Typical C-E leakage current as a function of junction temperature
 ($V_{CE}=1200V, V_{GE}=0V$)

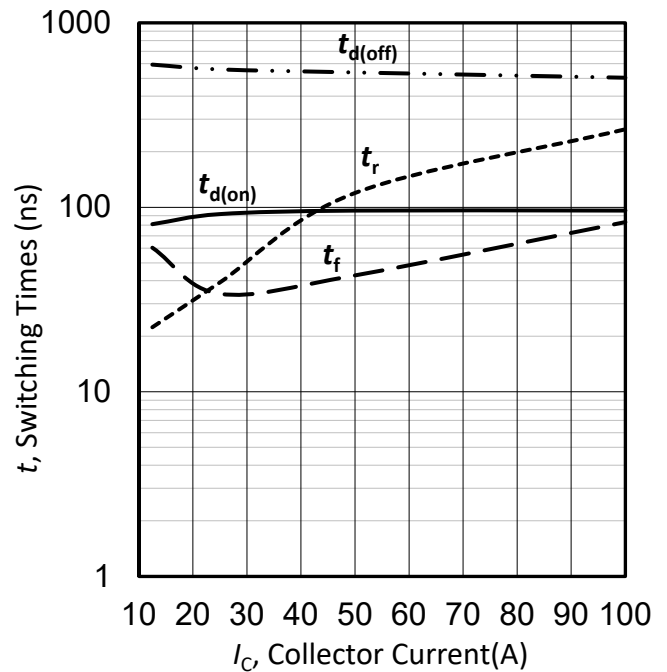

Figure 10. Typical switching times as a function of collector current
 (inductive load, $T_{vj}=25^{\circ}C$,
 $V_{CE}=600V, V_{GE}=0/15V, R_G=10\Omega$)

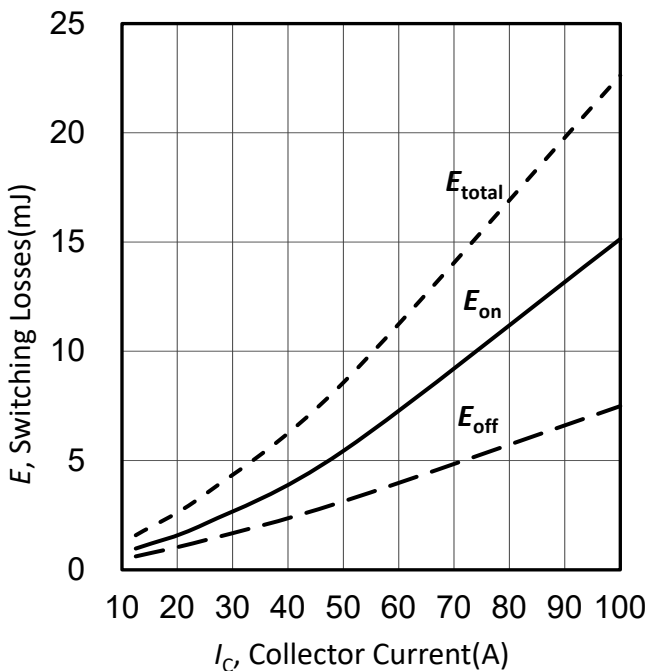

Figure 11. Typical switching energy losses as a function of collector current
 (inductive load, $T_{vj}=25^{\circ}C$,
 $V_{CE}=600V, V_{GE}=0/15V, R_G=10\Omega$)

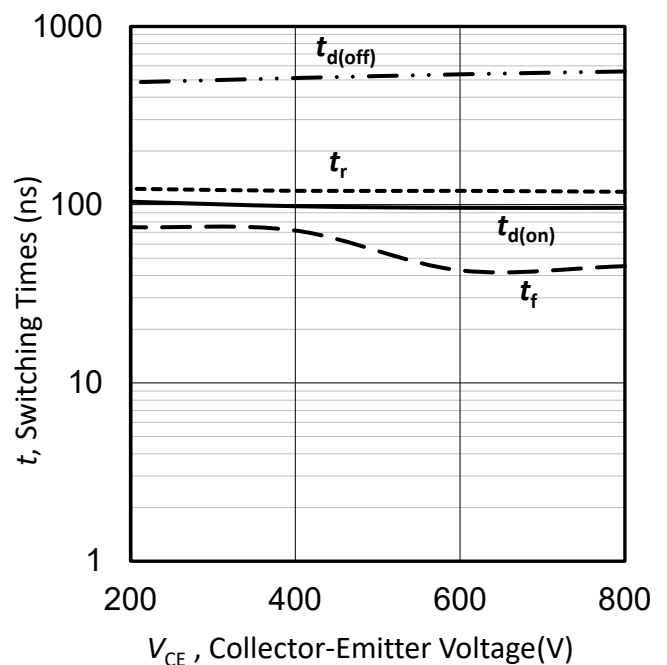

Figure 12. Typical switching times as a function of collector emitter voltage
 (inductive load, $T_{vj}=25^{\circ}C$,
 $I_C=50A, V_{GE}=0/15V, R_G=10\Omega$)

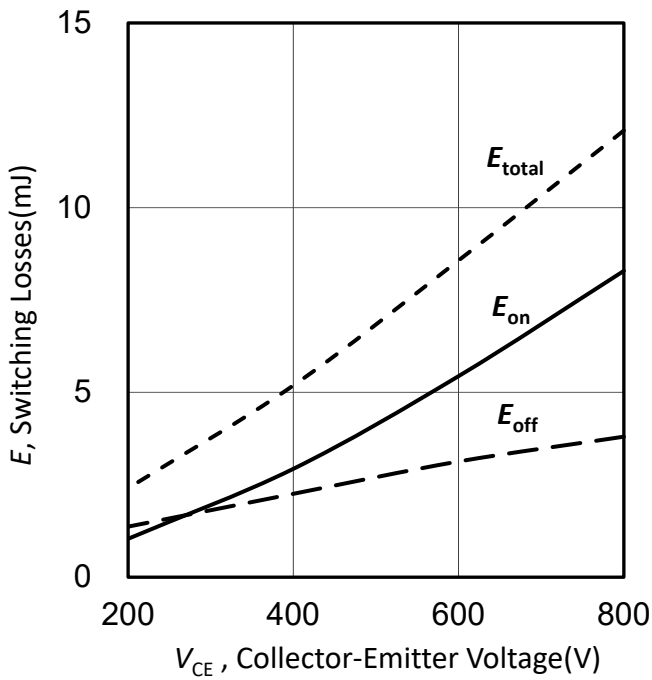

Figure 13. Typical switching energy losses as a function of collector emitter voltage
(inductive load, $T_{vj}=25^{\circ}\text{C}$,
 $I_C=50\text{A}$, $V_{GE}=0/15\text{V}$, $R_G=10\Omega$)

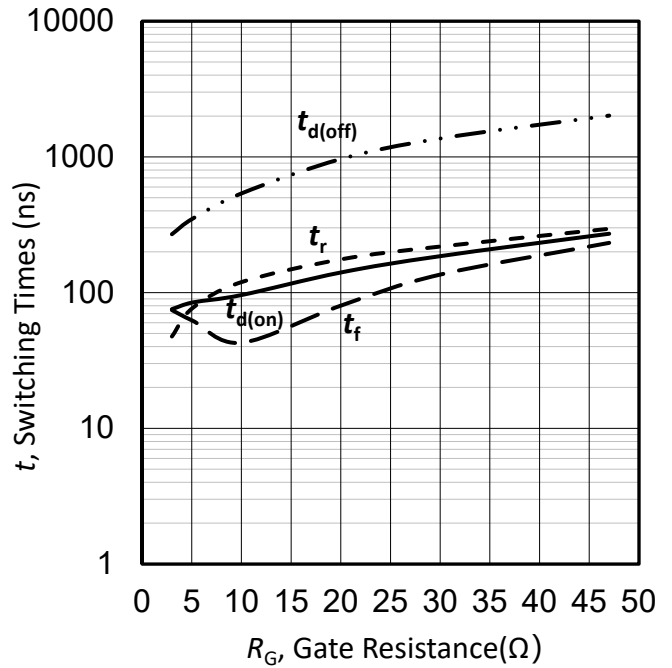

Figure 14. Typical switching times as a function of gate resistor
(inductive load, $T_{vj}=25^{\circ}\text{C}$,
 $V_{CE}=600\text{V}$, $V_{GE}=0/15\text{V}$, $I_C=50\text{A}$)

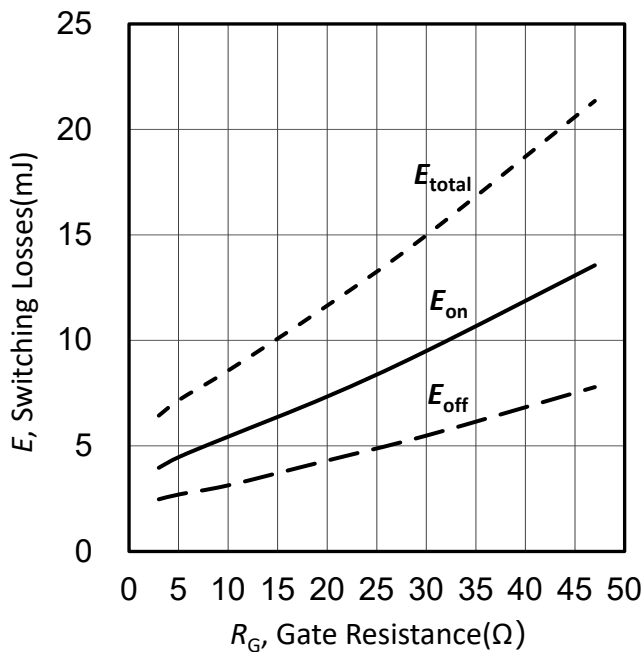

Figure 15. Typical switching energy losses as a function of gate resistor
(inductive load, $T_{vj}=25^{\circ}\text{C}$,
 $V_{CE}=600\text{V}$, $V_{GE}=0/15\text{V}$, $I_C=50\text{A}$)

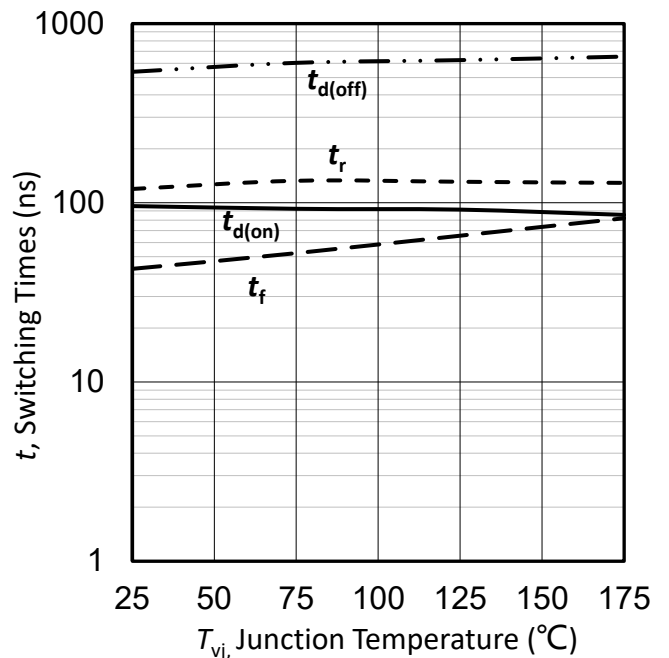

Figure 16. Typical switching times as a function of junction temperature
(inductive load, $V_{CE}=600\text{V}$, $V_{GE}=0/15\text{V}$,
 $I_C=50\text{A}$, $R_G=10\Omega$)

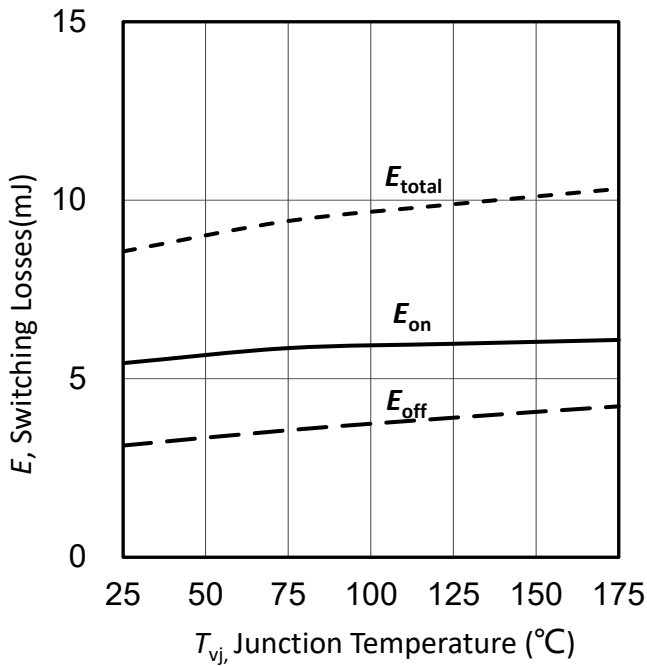

Figure 17. Typical switching energy losses as a function of junction temperature
(inductive load, $V_{CE}=600V$, $V_{GE}=0/15V$, $I_C=50A$, $R_G=10\Omega$)

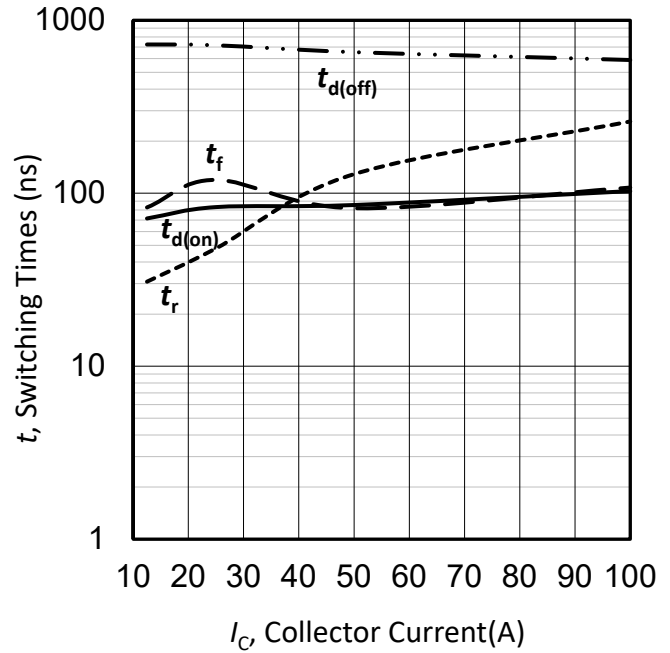

Figure 18. Typical switching times as a function of collector current
(inductive load, $T_{vj}=175^\circ C$, $V_{CE}=600V$, $V_{GE}=0/15V$, $R_G=10\Omega$)

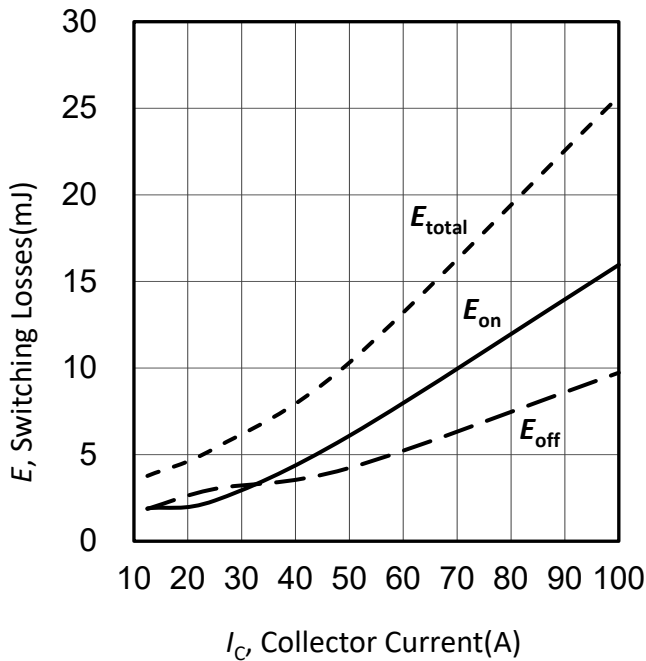

Figure 19. Typical switching energy losses as a function of collector current
(inductive load, $T_{vj}=175^\circ C$, $V_{CE}=600V$, $V_{GE}=0/15V$, $R_G=10\Omega$)

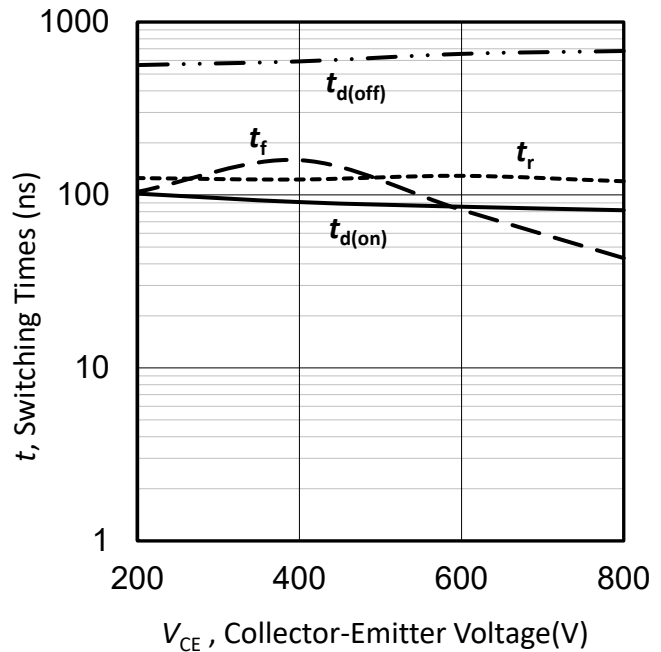

Figure 20. Typical switching times as a function of collector emitter voltage
(inductive load, $T_{vj}=175^\circ C$, $I_C=50A$, $V_{GE}=0/15V$, $R_G=10\Omega$)

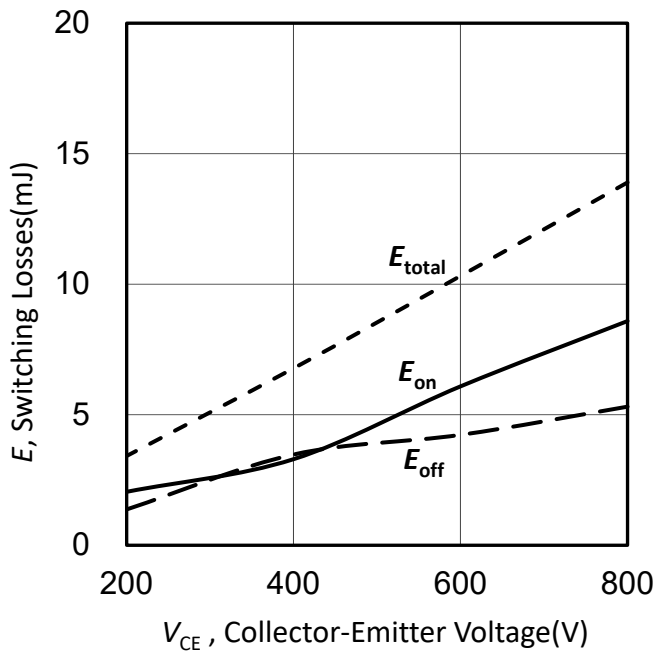

Figure 21. Typical switching energy losses as a function of collector emitter voltage (inductive load, $T_{vj}=175^{\circ}\text{C}$, $I_C=50\text{A}$, $V_{GE}=0/15\text{V}$, $R_G=10\Omega$)

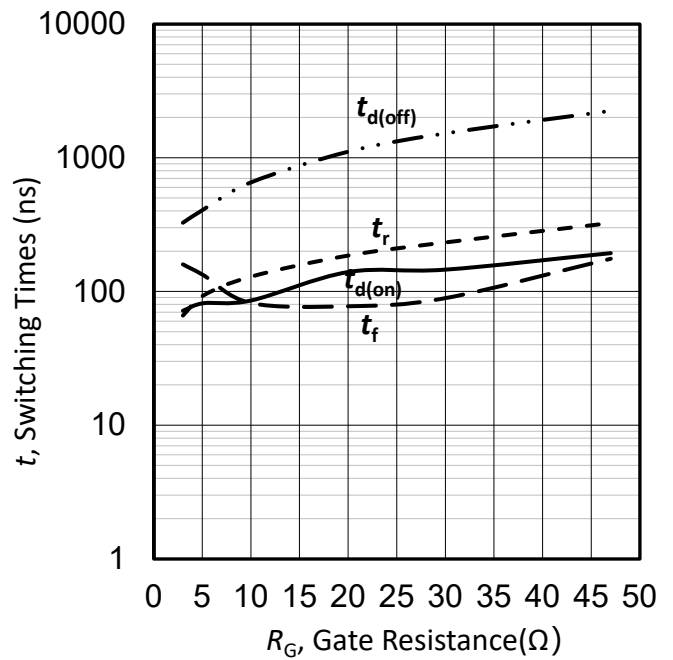

Figure 22. Typical switching times as a function of gate resistor (inductive load, $T_{vj}=175^{\circ}\text{C}$, $V_{CE}=600\text{V}$, $V_{GE}=0/15\text{V}$, $I_C=50\text{A}$)

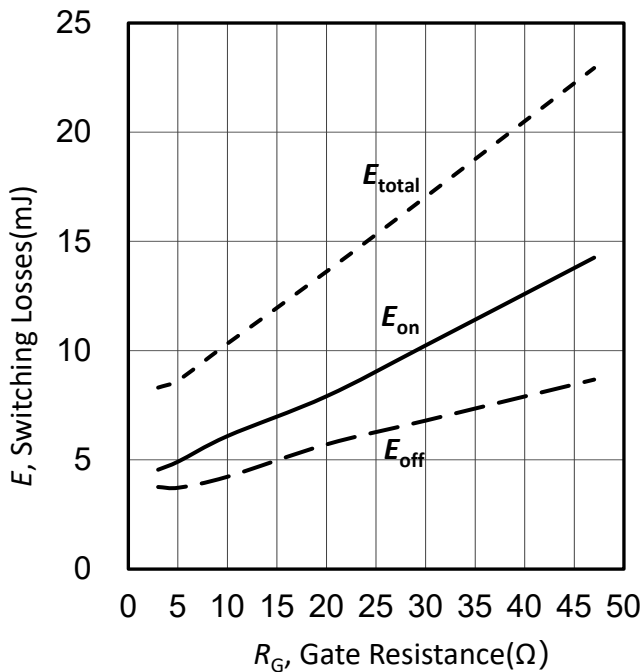

Figure 23. Typical switching energy losses as a function of gate resistor (inductive load, $T_{vj}=175^{\circ}\text{C}$, $V_{CE}=600\text{V}$, $V_{GE}=0/15\text{V}$, $I_C=50\text{A}$)

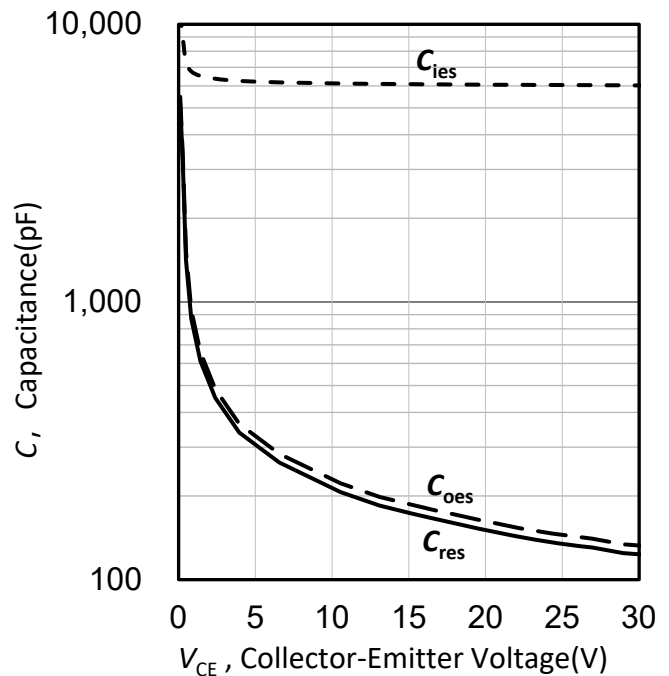

Figure 24. Typical capacitance as a function of collector-emitter voltage

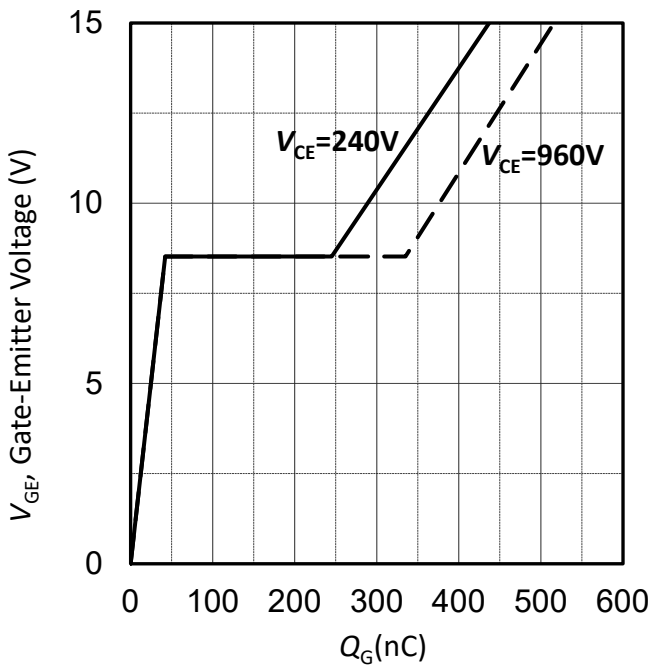

Figure 25. Typical gate charge ($I_C=50A$)

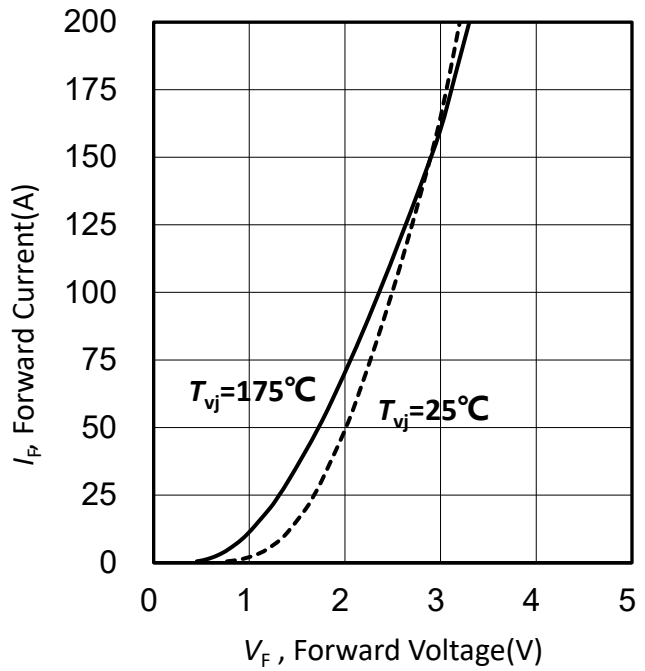

Figure 26. Typical diode forward current as a function of forward voltage

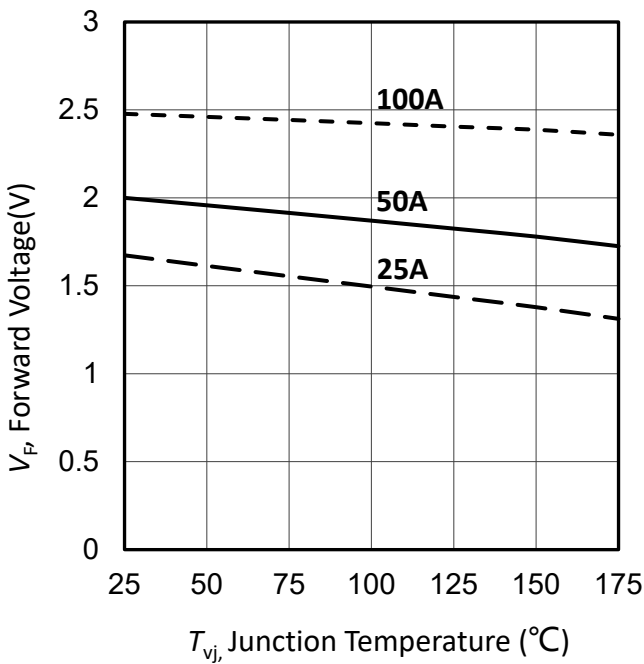

Figure 27. Typical diode forward voltage as a function of junction temperature

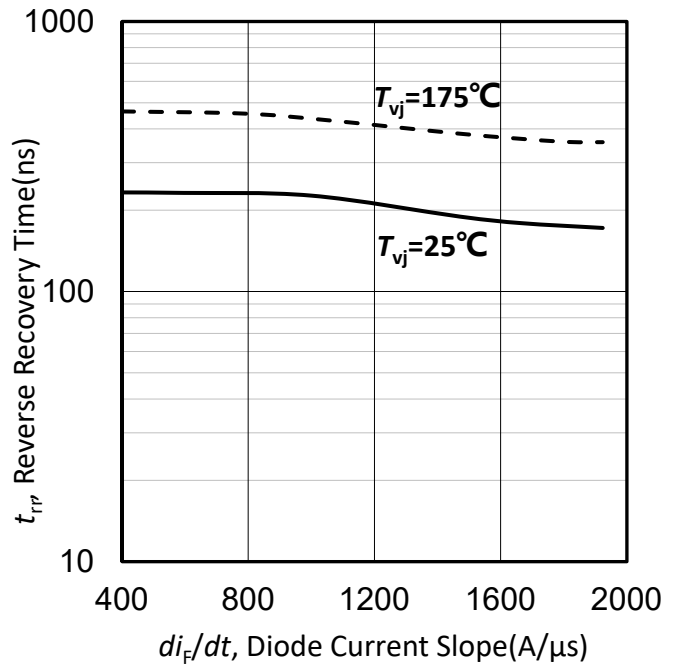

Figure 28. Typical reverse recovery time as a function of diode current slope ($V_R=600V$)

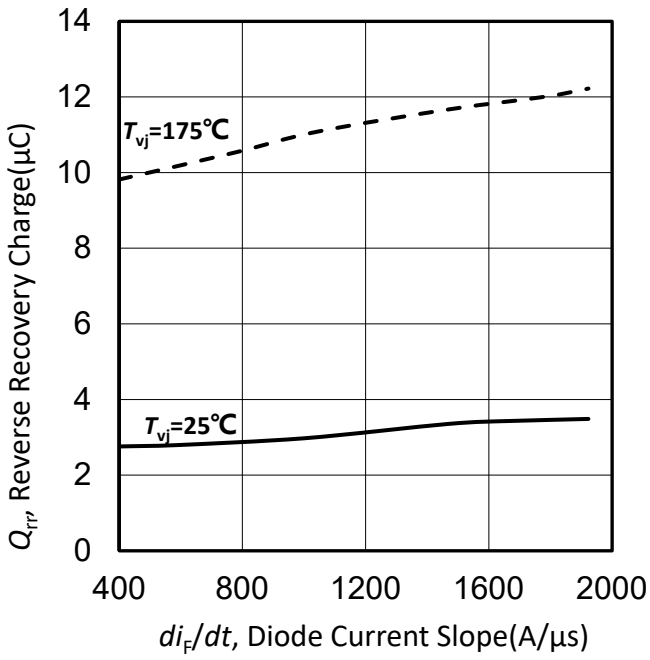

Figure 29. Typical reverse recovery charge as a function of diode current slope ($V_R=600\text{V}$)

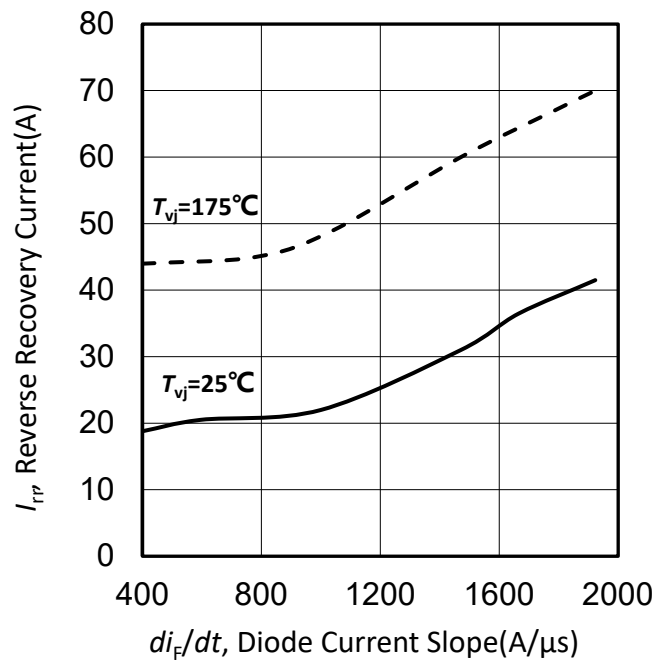

Figure 30. Typical reverse recovery current as a function of diode current slope ($V_R=600\text{V}$)

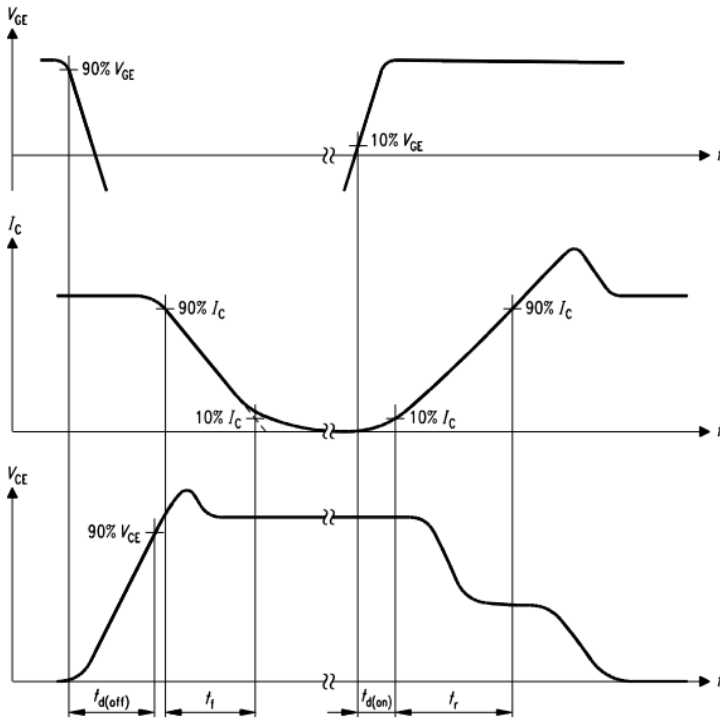

Figure A. Definition of switching times

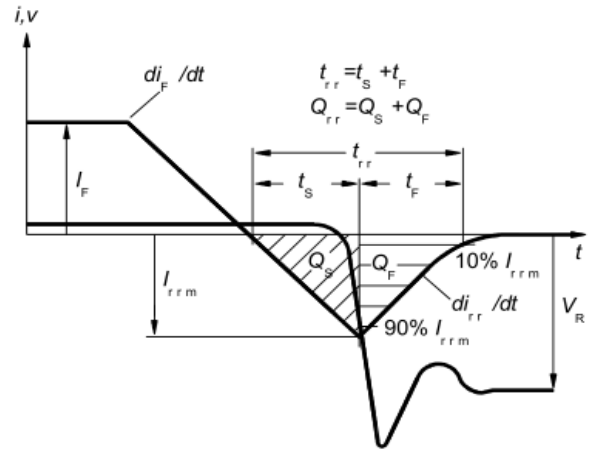

Figure C. Definition of diodes switching characteristics

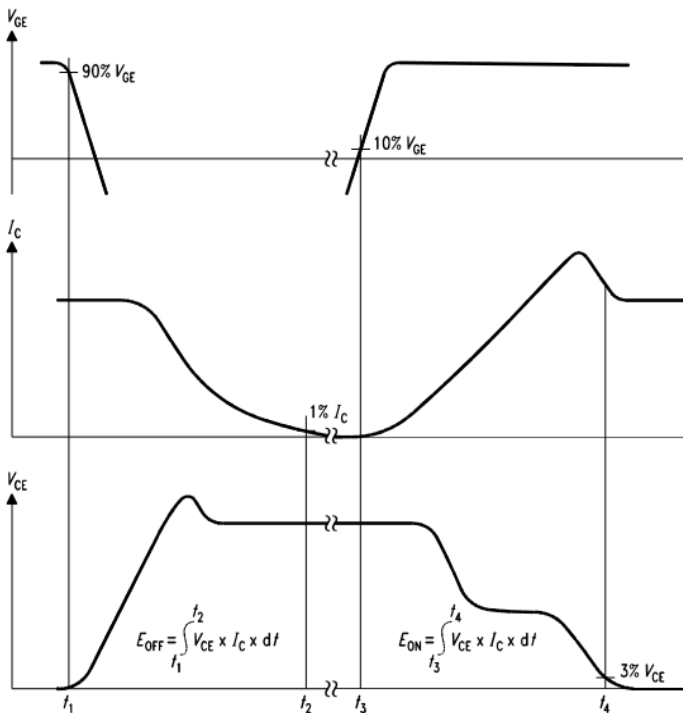

Figure B. Definition of switching losses

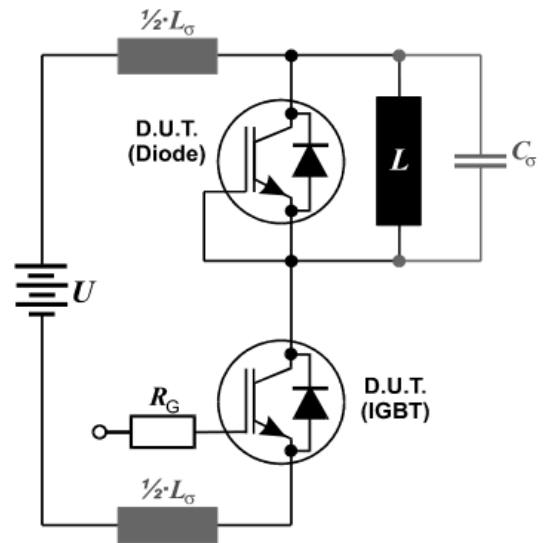
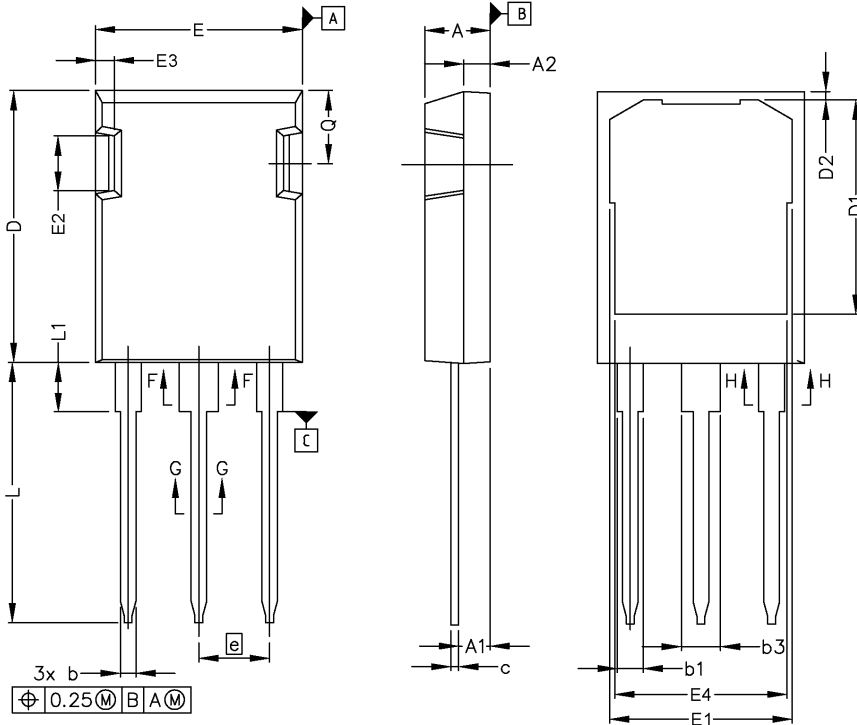

Figure D. Switching test circuit

TO-247-3L Plus



SYMBOL	MIN	MAX
A	4.83	5.21
A1	2.29	2.54
A2	1.91	2.16
b'	1.07	1.28
b	1.07	1.33
b1	1.91	2.41
b2	1.91	2.16
b3	2.87	3.38
b4	2.87	3.13
c'	0.55	0.65
c	0.55	0.68
D	20.80	21.10
D1	16.25	17.65
D2	0.50	0.80
E	15.75	16.13
E1	13.10	14.15
E2	3.68	5.10
E3	1.00	1.90
E4	12.38	13.43
e	5.44 BSC	
N	3	
L	19.81	20.32
L1	3.70	4.00
Q	5.49	6.00

NOTE:
 1. ALL METAL SURFACES, TIN PLATED, EXCEPT AREA OF CUT
 2. DIMENSIONING & TOLERANCING CONFIRM TO ASME Y14.5M-1994.
 3. ALL DIMENSIONS ARE IN MILLIMETERS. ANGLES ARE IN DEGREES.
 4. THIS DRAWING WILL MEET ALL DIMENSIONS REQUIREMENT OF JEDEC outlines TO-247 AD.

- 1 - GATE
- 2 - DRAIN (COLLECTOR)
- 3 - SOURCE (EMITTER)
- 4 - DRAIN (COLLECTOR)

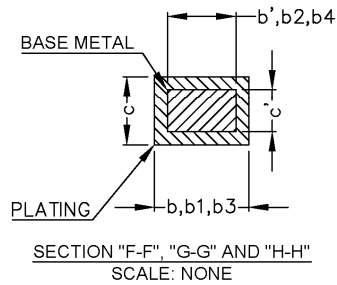



Revision History

Revision	Subjects (major changes since last revision)	Date
1.0	Initial version	2021.9

Terms & Conditions of usage

1. The product specifications, characteristics, data, materials and structures given in this datasheet are subject to change without notice.
2. The information given in this datasheet shall in no event be regarded as a guarantee of conditions or characteristics. Marching-Power Technology Co., Ltd. does not warrant or assume any legal liability or responsibility for the accuracy and completeness of any examples, hints or any typical values stated herein and/or any information regarding the application of the product.
3. This datasheet is only used as a reference for customers to apply our products, Marching-Power Technology Co., Ltd. does not undertake to permit the use of intellectual property rights or any third-party property rights related to the product information described in this datasheet.
4. Although Marching-Power Technology Co., Ltd. is committed to enhancing product quality and reliability, all semiconductor products still have a probability of failure. When using Marching-Power semiconductor products in your equipment, you are requested to take adequate safety measures to prevent the equipment from causing accidents or events including but not limited to physical injury, fire or damage to other property if any of the products become faulty.
5. The products introduced in this datasheet are electrostatic sensitive devices and must be protected against static electricity during device installation, testing, packaging, storage and transportation.
6. Do not use the products introduced in this datasheet in equipment or systems that requiring strict reliability or/and may directly endanger human life such as medical, life-saving, life-sustaining, space equipment, aeronautic equipment, nuclear equipment submarine repeater equipment and equivalents to strategic equipment (without limitation).
7. No part of this datasheet may be disseminated and reproduced in any form or by any means without prior written permission from Marching-Power Technology Co., Ltd.
8. The data contained in this datasheet is exclusively intended for use by professional technicians only. It is the responsibility of the customer's own technical departments to evaluate the suitability of the product for the intended application and the completeness of the product information given in this document with respect to corresponding application. If you have any question about any portion in this datasheet, contact Marching-Power Technology Co., Ltd. before using the product. Marching-Power Technology Co., Ltd. shall not be liable for any injury caused by any use of the products not in accordance with instructions set forth herein.