

Features

- Easy parallel switching capability due to positive temperature coefficient in V_{CEsat}
- Low V_{CEsat} , fast switching
- High ruggedness, good thermal stability
- Very tight parameter distribution

Applications

- UPS
- PFC
- PTC Heater
- Climate Compressor

Type	Marking	Package Code
MPBW50N65ED	MP50N65ED	TO-247-3

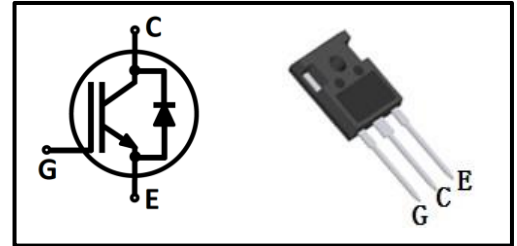

Maximum Rated Values ¹

Parameter	Symbol	Value	Unit
Collector-emitter voltage	V_{CE}	650	V
DC collector current ²			A
$T_C=25^\circ\text{C}$	I_C	80	
$T_C=100^\circ\text{C}$		50	
Pulsed collector current ³	I_{Cpuls}	200	
Diode forward current ²			
$T_C=25^\circ\text{C}$	I_F	80	
$T_C=100^\circ\text{C}$		50	
Diode pulsed current ³	I_{Fpuls}	200	
Gate-emitter voltage	V_{GE}	± 20	V
Transient Gate-emitter voltage ($t_p \leq 10\mu\text{s}$)		± 30	
Power dissipation			W
$T_C=25^\circ\text{C}$	P_{tot}	300	
$T_C=100^\circ\text{C}$		150	
Operating junction temperature	T_j	-55~175	$^\circ\text{C}$
Storage temperature	T_{stg}	-55~150	

1:Reference standard: JESD-022 2: limited by T_{jmax} 3: T_p limited by T_{jmax} ;



Thermal Characteristics

Parameter	Symbol	Min	Typ	Max	Unit
IGBT thermal resistance, junction-case	R_{thJC}	-	-	0.5	K/W
Diode thermal resistance, junction-case	R_{thJCD}	-	-	0.65	
Thermal Resistance, junction-ambient	R_{thJA}	-	-	40	

Electrical Characteristics (at $T_j=25^\circ\text{C}$, unless otherwise specified) Static Characteristics

Parameter	Symbol	Conditions	Min	Typ	Max	Unit
Collector-emitter breakdown voltage	$V_{(BR)CES}$	$V_{GE}=0V, I_C=0.25mA$	650	-	-	V
Collector-emitter saturation voltage	$V_{CE(sat)}$	$V_{GE}=15V, I_C=50A, T_j=25^\circ\text{C}$	-	1.60	1.90	
		$T_j=125^\circ\text{C}$	-	1.72	-	
		$T_j=150^\circ\text{C}$	-	1.80	-	
Diode forward voltage	V_F	$V_{GE}=0V, I_F=50A, T_j=25^\circ\text{C}$	-	1.95	2.25	
		$T_j=125^\circ\text{C}$	-	1.87	-	
		$T_j=150^\circ\text{C}$	-	1.82	-	
G-E threshold voltage	$V_{GE(th)}$	$I_C=1mA, V_{CE}=V_{GE}$	4.5	5.5	6.5	
C-E leakage current	I_{CES}	$V_{CE}=650V, V_{GE}=0V, T_j=25^\circ\text{C}$	-	-	0.01	
		$T_j=150^\circ\text{C}$	-	-	1.0	
G-E leakage current	I_{GES}	$V_{CE}=0V, V_{GE}=20V$	-	-	250	nA
Transconductance	g_{FS}	$V_{CE}=20V, I_C=50A$	-	21	-	S

Dynamic Characteristics

Parameter	Symbol	Conditions	Min	Typ	Max	Unit
Input capacitance	C_{iss}	$V_{CE}=25V, V_{GE}=0V, f=1MHz$	-	5810	-	pF
Output capacitance	C_{oss}		-	130	-	
Reverse transfer capacitance	C_{riss}		-	65	-	
Gate charge	Q_G	$V_{CC}=300V, I_C=50A, V_{GE}=15V$	-	230	-	nC



IGBT Switching Characteristics

Parameter	Symbol	Conditions	Min	Typ	Max	Unit	
Turn-on delay time	$t_{d(on)}$	$T_j=25^{\circ}\text{C}$, $V_{CC}=400\text{V}$, $I_C=50\text{A}$, $V_{GE}=0/15\text{V}$, $R_G=10\Omega$, Inductive load	-	107	-	ns	
Rise time	t_r		-	62	-		
Turn-off delay time	$t_{d(off)}$		-	265	-		
Fall time	t_f		$T_j=150^{\circ}\text{C}$, $V_{CC}=400\text{V}$, $I_C=50\text{A}$, $V_{GE}=0/15\text{V}$, $R_G=10\Omega$, Inductive load	-	48	-	mJ
Turn-on energy	E_{on}			-	0.90	-	
Turn-off energy	E_{off}			-	1.12	-	
Total switching energy	E_{ts}			-	2.02	-	
Turn-on delay time	$t_{d(on)}$	$T_j=150^{\circ}\text{C}$, $V_{CC}=400\text{V}$, $I_C=50\text{A}$, $V_{GE}=0/15\text{V}$, $R_G=10\Omega$, Inductive load	-	100	-	ns	
Rise time	t_r		-	62	-		
Turn-off delay time	$t_{d(off)}$		-	335	-		
Fall time	t_f		$T_j=150^{\circ}\text{C}$, $V_{CC}=400\text{V}$, $I_C=50\text{A}$, $V_{GE}=0/15\text{V}$, $R_G=10\Omega$, Inductive load	-	50	-	mJ
Turn-on energy	E_{on}			-	1.35	-	
Turn-off energy	E_{off}			-	1.40	-	
Total switching energy	E_{ts}			-	2.75	-	

Diode Characteristics

Parameter	Symbol	Conditions	Min	Typ	Max	Unit
Diode reverse recovery time	t_{rr}	$T_j=25^{\circ}\text{C}$, $V_R=400\text{V}$, $I_F=50\text{A}$, $di_F/dt=640\text{A}/\mu\text{s}$	-	57	-	ns
Diode reverse recovery charge	Q_{rr}		-	0.39	-	μC
Diode peak reverse recovery current	I_{rrm}		-	10.6	-	A
Diode reverse recovery time	t_{rr}	$T_j=150^{\circ}\text{C}$, $V_R=400\text{V}$, $I_F=50\text{A}$, $di_F/dt=640\text{A}/\mu\text{s}$	-	92.8	-	ns
Diode reverse recovery charge	Q_{rr}		-	1.48	-	μC
Diode peak reverse recovery current	I_{rrm}		-	24	-	A

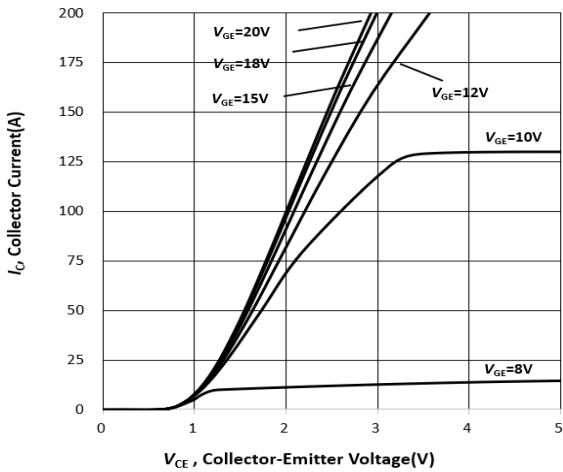

Figure 1. Typical output characteristic ($T_j = 25^\circ\text{C}$)

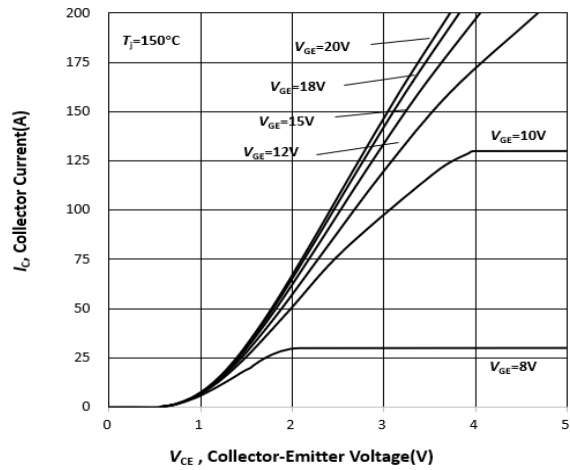

Figure 2. Typical output characteristic ($T_j = 150^\circ\text{C}$)

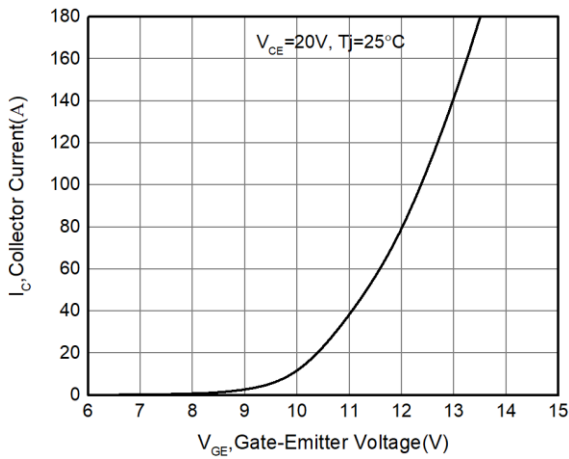

Figure 3. Typical transfer characteristic ($T_j = 25^\circ\text{C}$)

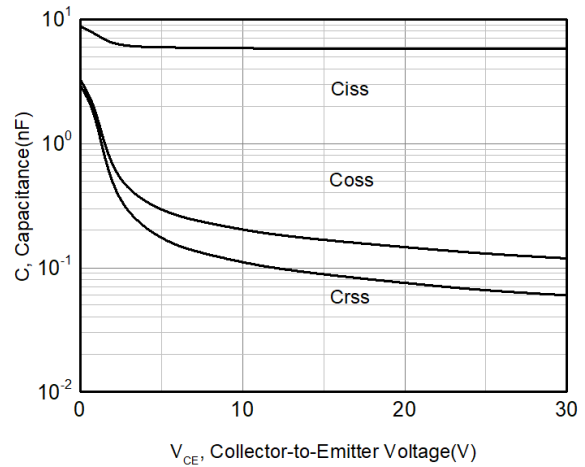

Figure 4. Capacitance characteristic ($V_{GE} = 0\text{V}$, $f = 1\text{MHz}$)

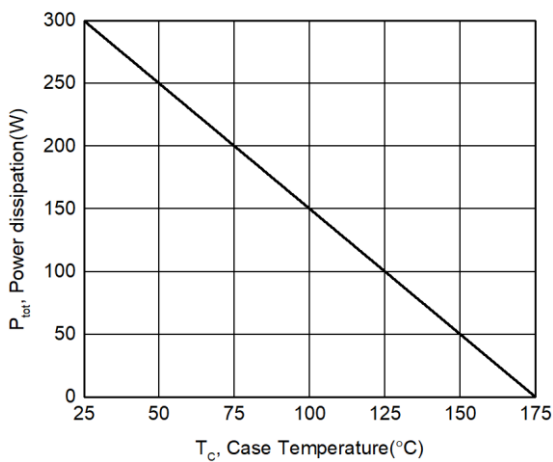

Figure 5. Power dissipation as a function of case temperature ($T_j \leq 175^\circ\text{C}$)

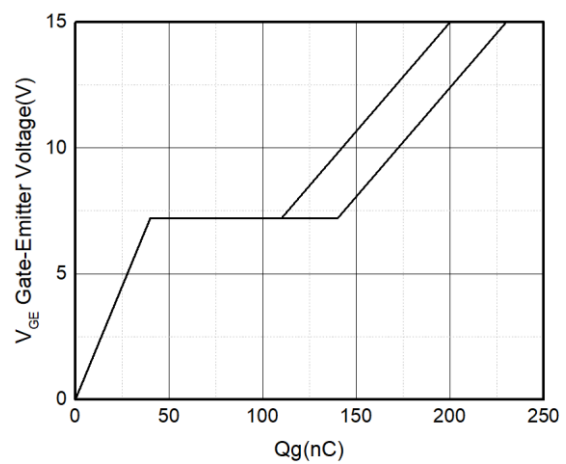

Figure 6. Typical gate charge ($I_C = 50\text{A}$)

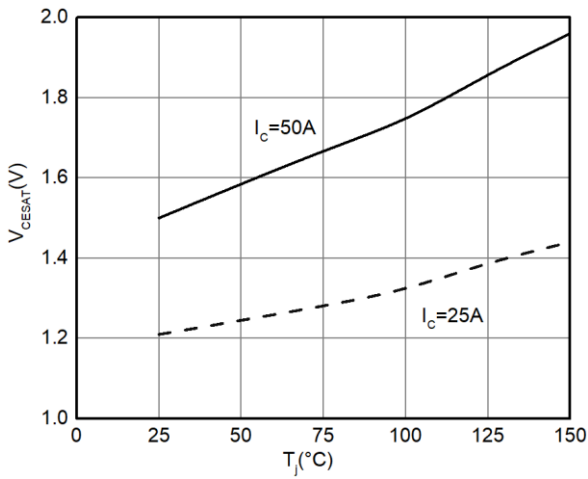

Figure 7. V_{CESAT} as a function of junction temperature ($V_{GE}=15V$)

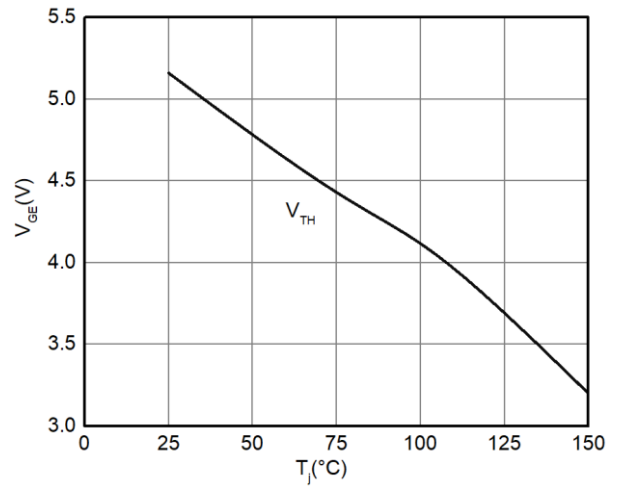

Figure 8. V_{TH} as a function of junction temperature ($I_{CE}=250\mu A$)

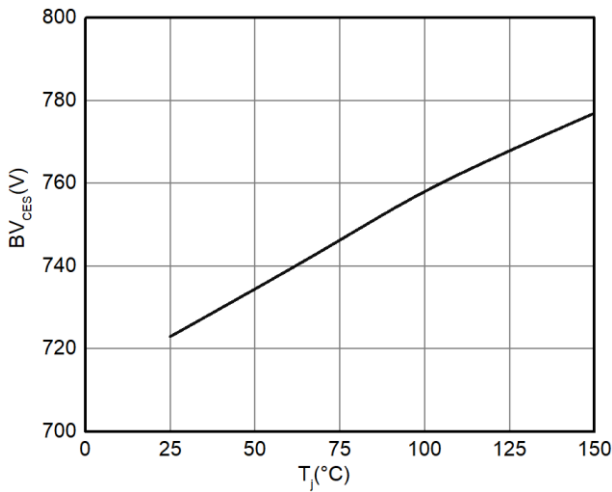

Figure 9. BV as a function of junction temperature ($I_{CE}=250\mu A$)

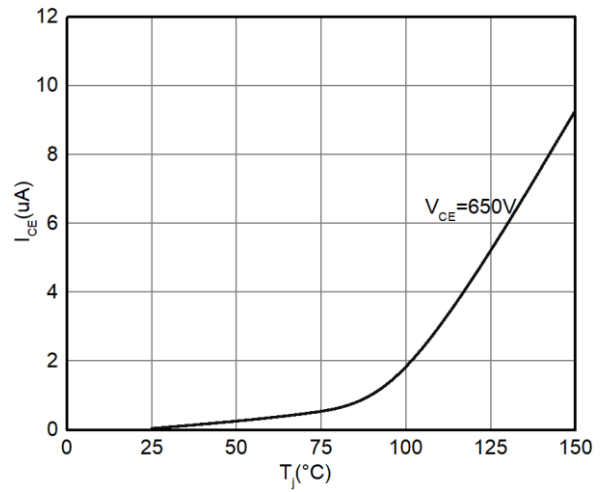

Figure 10. I_{CES} leakage current as a function of junction temperature

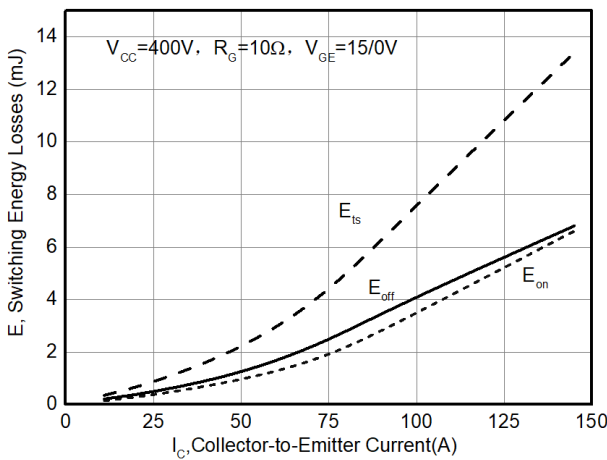

Figure 11. E_{on} , E_{off} as a function of I_C ($T_f=25^\circ C$)

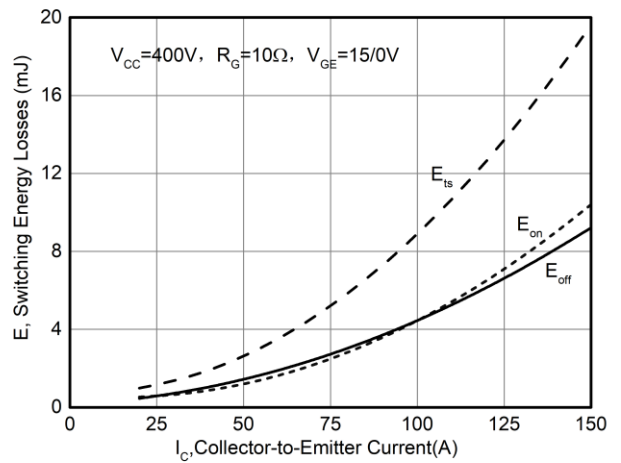

Figure 12. E_{on} , E_{off} as a function of I_C ($T_f=150^\circ C$)

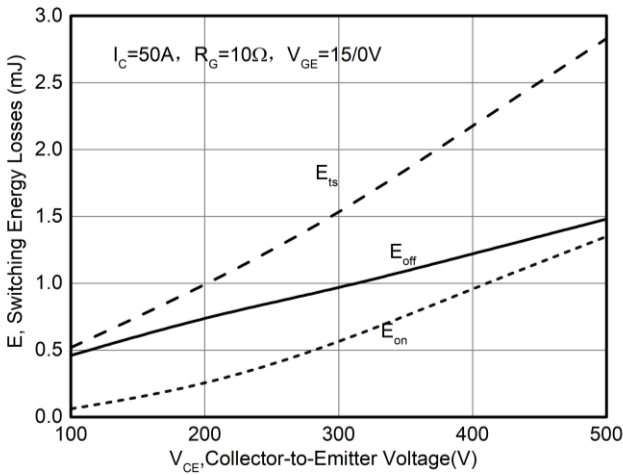

Figure 13. E_{on}, E_{off} as a function of V_{CE} ($T_j=25^{\circ}C$)

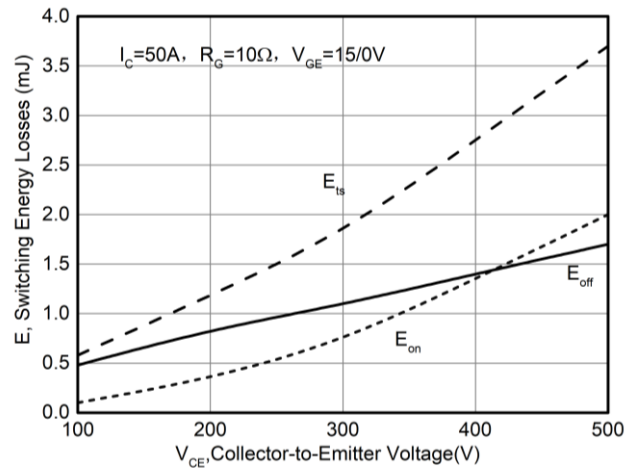

Figure 14. E_{on}, E_{off} as a function of V_{CE} ($T_j=150^{\circ}C$)

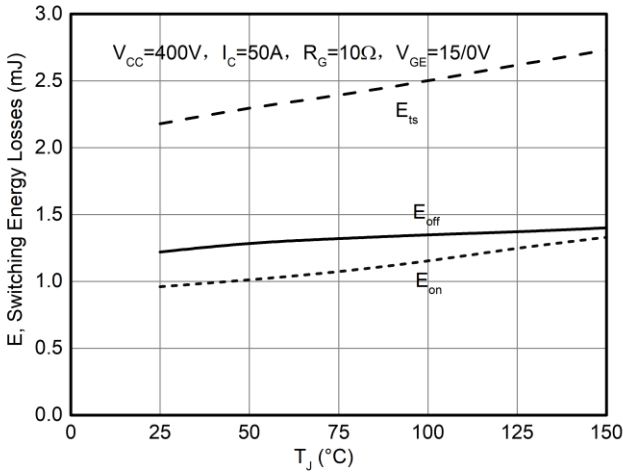

Figure 15. E_{on}, E_{off} as a function of T_j

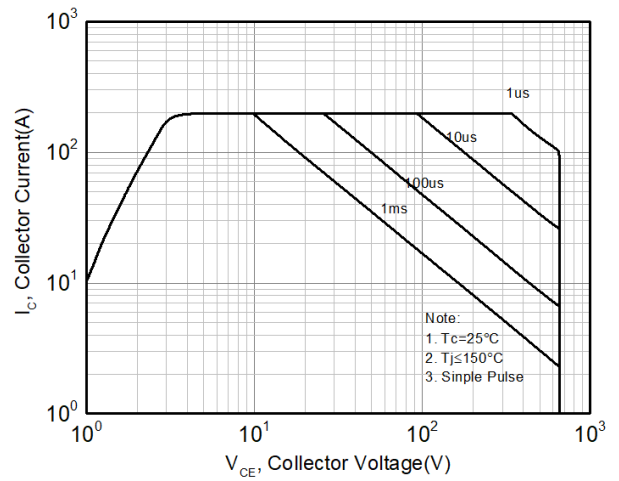

Figure 16. FBSOA

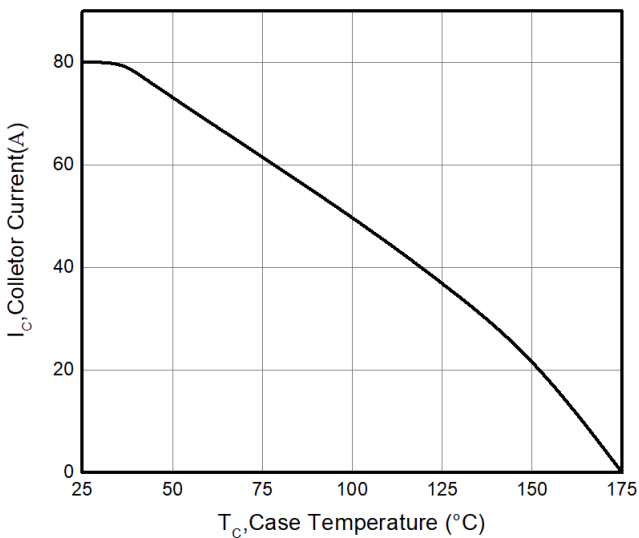
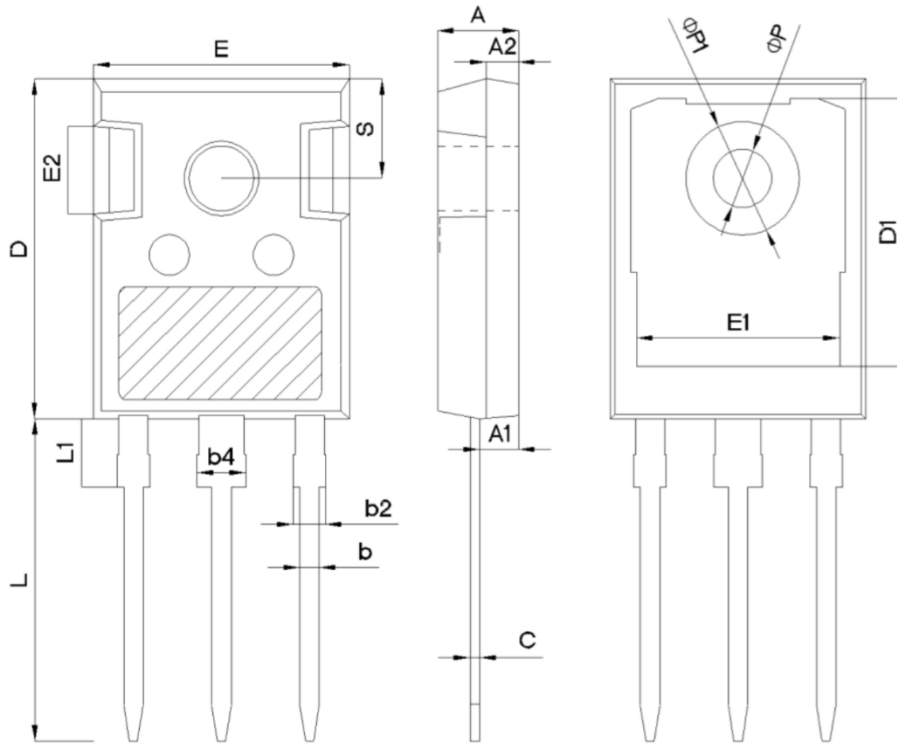

Figure 17. Collector current as a function of case temperature ($V_{GE} \geq 15V, T_j \leq 175^{\circ}C$)

TO-247



SYMBOL	mm		
	MIN	NOM	MAX
A	4.80	5.00	5.20
A1	2.21	2.41	2.61
A2	1.85	2.00	2.15
b	1.11	1.21	1.36
b2	1.91	2.01	2.21
b4	2.91	3.01	3.21
c	0.51	0.61	0.75
D	20.70	21.00	21.30
D1	16.25	16.55	16.85
E	15.50	15.80	16.10
E1	13.00	13.30	13.60
E2	4.80	5.00	5.20
E3	2.30	2.50	2.70
e	5.44BSC		
L	19.62	19.92	20.22
L1	-	-	4.30
ΦP	3.40	3.60	3.80
ΦP1	-	-	7.30
S	6.15BSC		



Revision History:

Revision	Date	Subjects (major changes since last revision)
1.0	2022-03	Initial Version
1.1	2022-06	Data supplement



Terms & Conditions of usage

1. The product specifications, characteristics, data, materials and structures given in this datasheet are subject to change without notice.
2. The information given in this datasheet shall in no event be regarded as a guarantee of conditions or characteristics. Marching-Power Technology Co., Ltd. does not warrant or assume any legal liability or responsibility for the accuracy and completeness of any examples, hints or any typical values stated herein and/or any information regarding the application of the product.
3. This datasheet is only used as a reference for customers to apply our products, Marching-Power Technology Co., Ltd. does not undertake to permit the use of intellectual property rights or any third-party property rights related to the product information described in this datasheet.
4. Although Marching-Power Technology Co., Ltd. is committed to enhancing product quality and reliability, all semiconductor products still have a probability of failure. When using Marching-Power semiconductor products in your equipment, you are requested to take adequate safety measures to prevent the equipment from causing accidents or events including but not limited to physical injury, fire or damage to other property if any of the products become faulty.
5. The products introduced in this datasheet are electrostatic sensitive devices and must be protected against static electricity during device installation, testing, packaging, storage and transportation.
6. Do not use the products introduced in this datasheet in equipment or systems that requiring strict reliability or/and may directly endanger human life such as medical, life-saving, life-sustaining, space equipment, aeronautic equipment, nuclear equipment submarine repeater equipment and equivalents to strategic equipment (without limitation).
7. No part of this datasheet may be disseminated and reproduced in any form or by any means without prior written permission from Marching-Power Technology Co., Ltd.
8. The data contained in this datasheet is exclusively intended for use by professional technicians only. It is the responsibility of the customer's own technical departments to evaluate the suitability of the product for the intended application and the completeness of the product information given in this document with respect to corresponding application. If you have any question about any portion in this datasheet, contact Marching-Power Technology Co., Ltd. before using the product. Marching-Power Technology Co., Ltd. shall not be liable for any injury caused by any use of the products not in accordance with instructions set forth herein.